



TRIAx



User guide

Model	Item no.
HDMI module	492030
AV module	492080

Version	891078D	10 - 2019	EN
---------	---------	-----------	----

triax.com

Contents

Contents

Disposal	3
Box content	3
HDMI module	3
Labels	4
Cover removal.....	4
Module installation.....	4
Module removal	5
Input cable installation.....	6
Status LED's	6
Log in	7
Input window	8
Configuration of HDMI input module.....	9
Status information.....	12
Delete setup.....	13
HDMI configuration	14
Update MPEG encoder module	15
Manufacturer	17
Your notes	18

Power / Grounding / ID switch

BEFORE powering up the main unit(s); it is very important to ground properly.

1. Connect an earth cable to Earth terminal of main unit(s)
2. Attach the other end of the earth cable to an approved earth connection point

Introduction

Disposal



Within in the European Union this label indicates that the product cannot be disposed of with the general household waste. Neither the headend nor the input and output modules can be disposed of with the general household waste.

For proper treatment and recycling of old products, please take them to designated collection points in accordance with your national legislation.

Box content

A new input module is wrapped in antistatic bubble wrap and packed in a cardboard box when you receive it.

Included in the box is a user guide instructing you how to use the TDX Service Tool to configure the module.

HDMI and AV module

The HDMI- and AV modules are some of the input modules that you can install in the input section of your TDX headend unit.

You can use the HDMI- and AV modules to connect:

- an analogue surveillance camera (AV only).
- a computer running a presentation.
- a set-top box (connected to a satellite disc, antenna or cable TV network) with a decryption card.
- a DVD player.

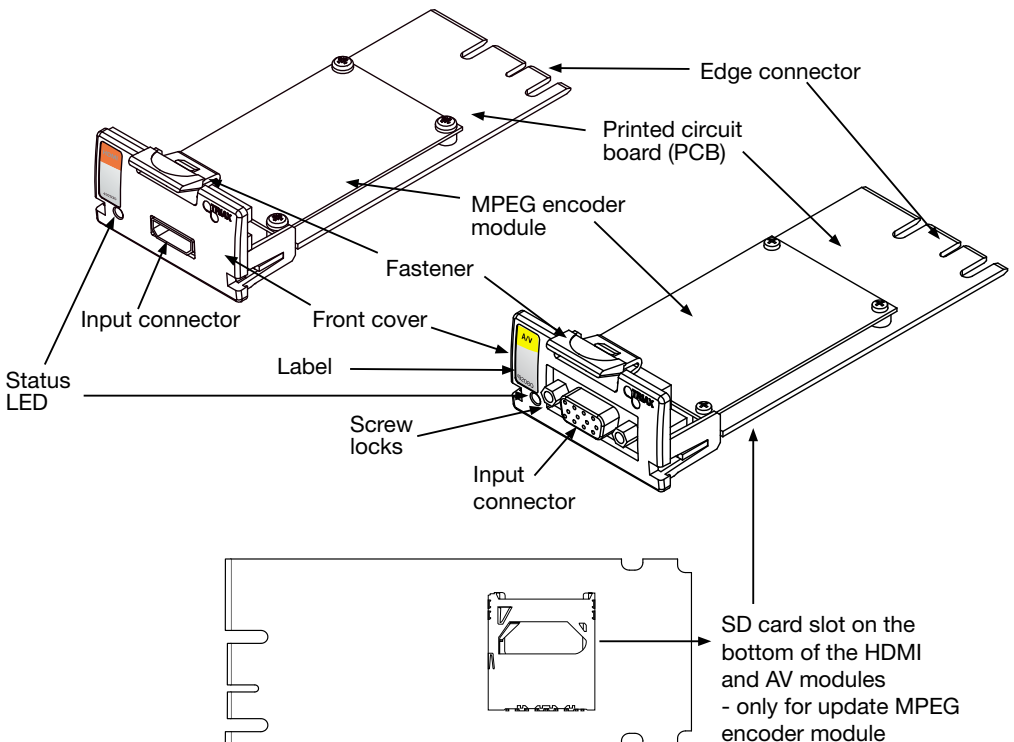

Basics

Labels

A label is placed on the front of the input module where you can write the information regarding the configuration of the module.

Besides the information that you write on the label, the module type and part number are also displayed on the label.

Note The coloured part at the top of the label informs you of the module type. Each type of module is allocated a unique coloured label.

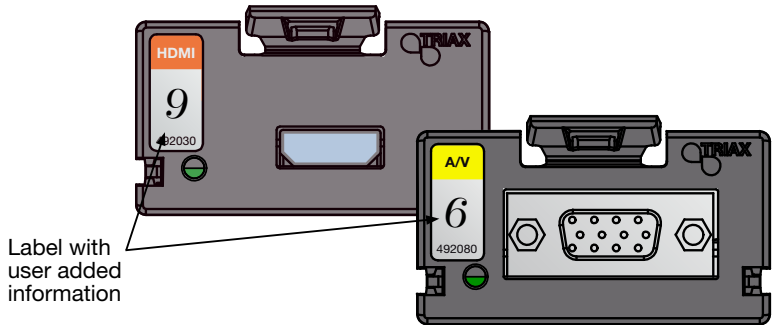

On the bottom of the module you will find a label with the bar code and a serial number printed on it.

Cover removal

Before you can install a module in the input section you have to remove the cover that protects the module slot.

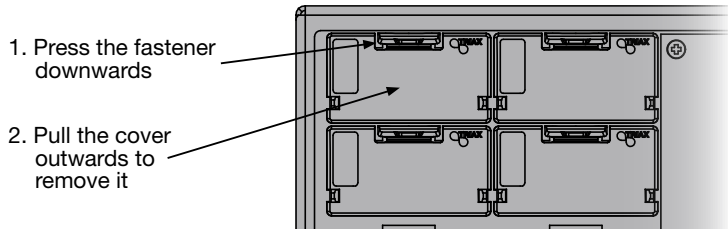

You do not need tools to remove the covers, just use your fingers.

For EMC and cooling reasons only remove covers from the module slots that you want to insert modules into.

Module installation

It is optional in which slots you place the individual input modules in the input section. For convenience each slot has been given a number, and an overview of the slot numbers has been placed on the inside of the door of each unit.

Note Slot no. 1 is placed in the top left-hand corner of the input section when you face the front of the unit.

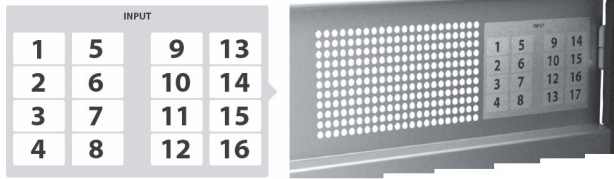

You install an input module by sliding the module into a module slot in the input section of the headend unit and push it till the module clicks into place.

- 1 Slide the module into a slot
- 2 Push the module until the fastener clicks into place

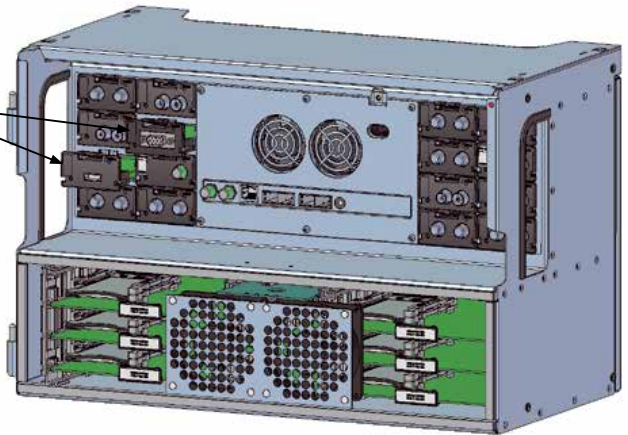

Note You can use hot swapping when you insert an input module into or remove an input module from the TDX system.

Module removal

It is possible to remove an input module from a module slot without using any tools, just use your fingers to press the fastener downwards and then pull the module outwards to remove it from the module slot.

- 1) Press the fastener downwards

- 2) Pull the module outwards to remove it from the module slot

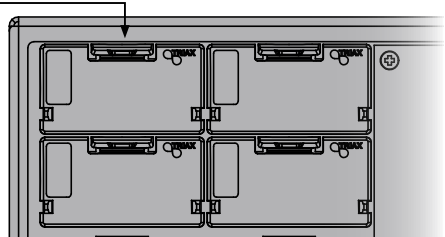

Basics

Input cable installation

When all the required input modules have been installed you can connect the input signal cables one by one to the input modules.

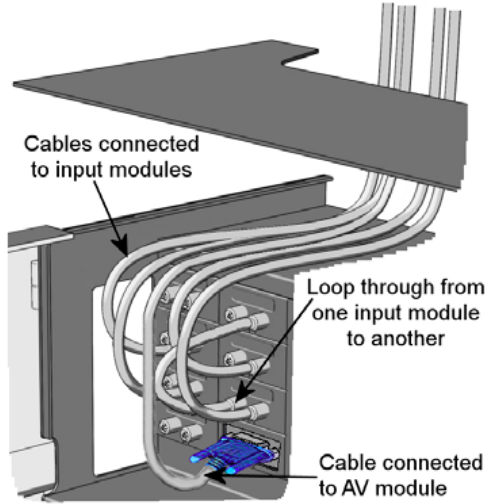

When you connect the cable to the input connector on the module, remember to tighten the screws connecting the AV plug to the connector.

Status LED

There is a status LED on the front of each module. The LED indicates whether the module has locked on to a frequency or needs to be configured.

- Green - flashing** The module has not been configured yet.
- Green** No error, MPEG encoding valid.
- Red** Module has been configured but no service has been detected.
- No colour** Power has not been switched on.

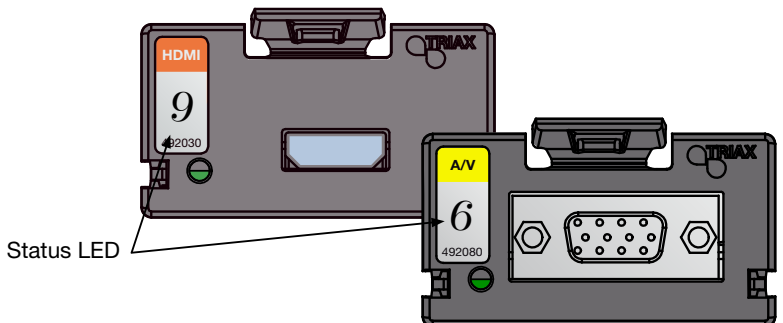

When you update the software of a module the status LED provides you with information about the updating process.

- Orange** Boot loader state.
- Temporary off** Initiation of the software update.
- Temporary green** Every time the modules receives a valid data package. Repeated until the update is completed without errors.
- Red** Software update failed.

Log in

When you have loaded the TDX Service Tool from the TDX headend system to your laptop/computer the Login window of TDX Service Tool is displayed.

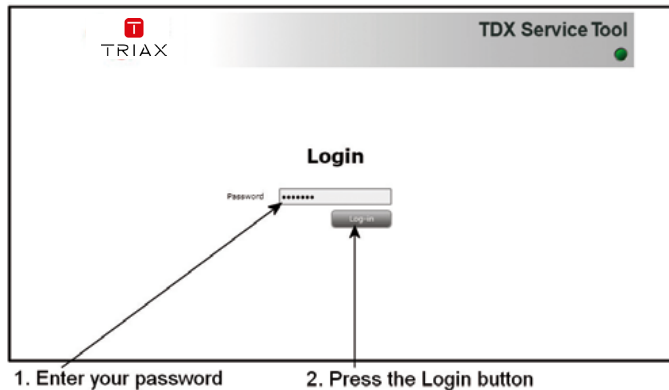

When you have pressed the Log in button the System window is displayed.

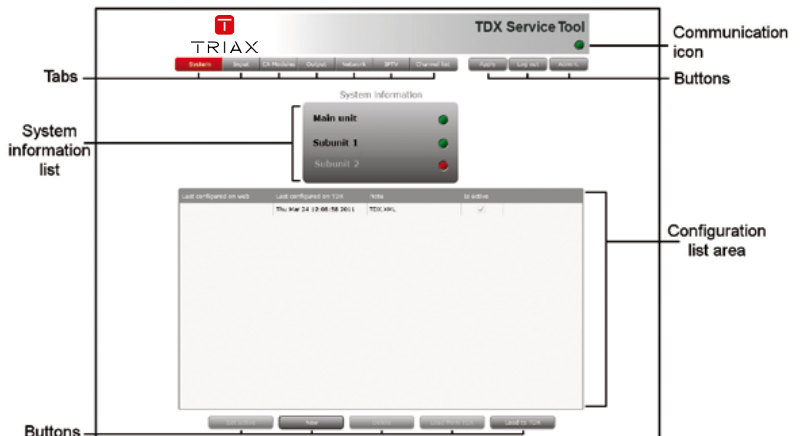

TDX Service Tool

Input window

Click the Input tab in the TDX Service Tool to display the Input window.

The first time you display the Input window in a new configuration the module list only displays the number and type of input modules that you have inserted in the main and subunits.

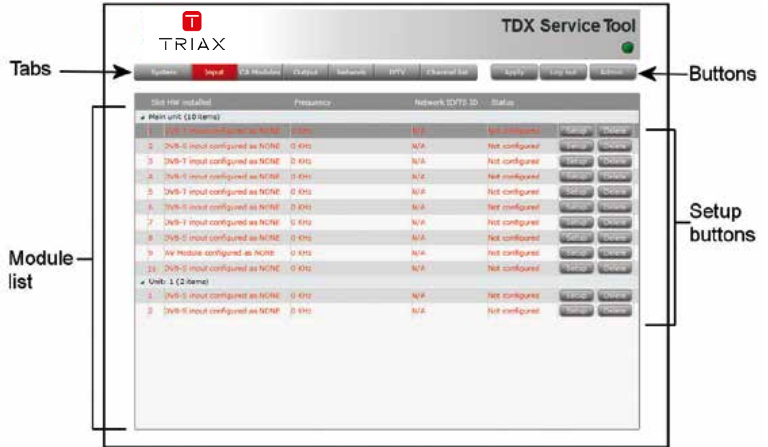

You have to configure the input modules individually.

To display the Configuration window, click the Setup button of the HDMI- and AV- input module you want to configure.

Note HDMI module requires the software 1.14.1.xxx

Please be sure that the right software is installed or make a update of the main unit before you install the HDMI module!

The actual software you will find at: <http://www.com.com>

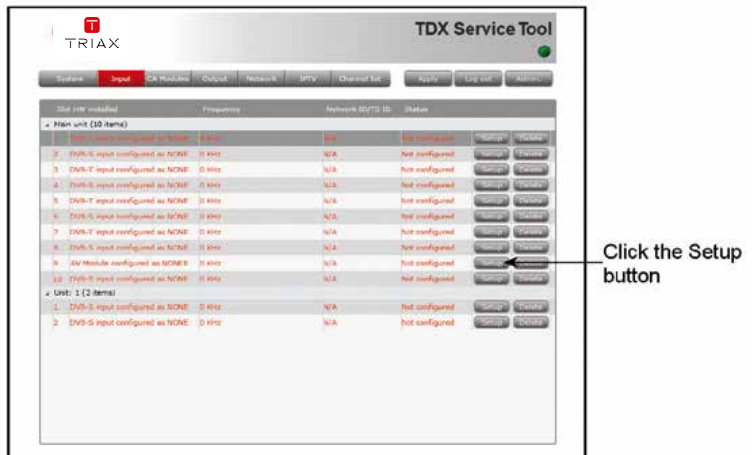

TDX Service Tool

Configuration of input module

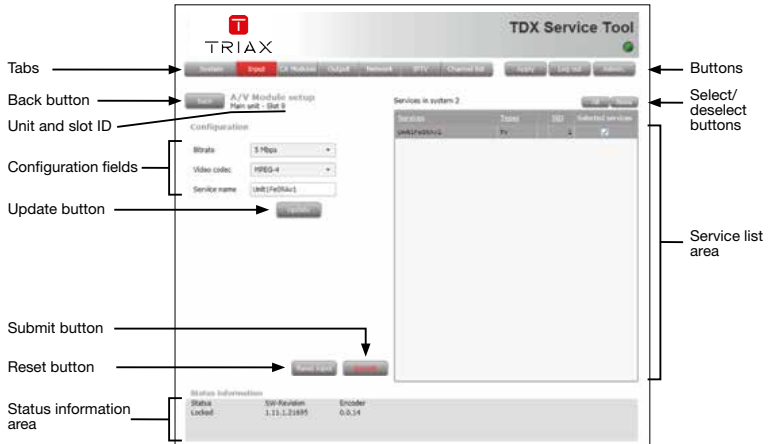

The first time the TDX Service Tool displays the Configuration window for an input module in a new configuration, the fields will display default values and the list of services will be empty.

Bitrate

To select the required bitrate, click the arrow to the right of the Bitrate field to open the drop-down list with the bitrates you can choose from.

Select the bitrate that matches the type of service you want to route to the TDX-pool.

Video codec

To select the required video codec, click the arrow to the right of the Video codec field to open the drop-down list with the codecs you can choose from.

Select the codec you want to use.

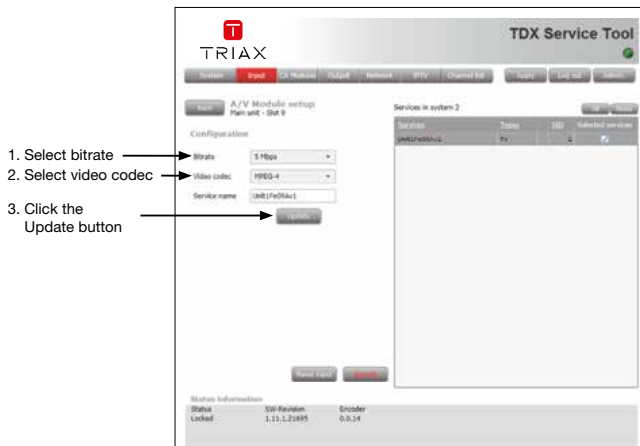

TDX Service Tool

Click the Update button to enter the information into the headend system.

As a result a service is displayed in the service list area.
(providing you connected/applied a source to the input)



Note From the instance you apply a valid source until it will appear - you should expect up to 1 min.

The name of the service listed in the service list area does not provide you with any information about which type of service it is. The name only states the position of the HDMI- and AV- input module in the TDX system.

HDMI or AV module

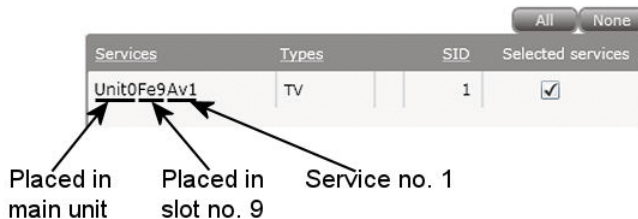

To select the service you can either click the All button at the top of the list or select the service by clicking the square to the right of the service.

TDX Service Tool

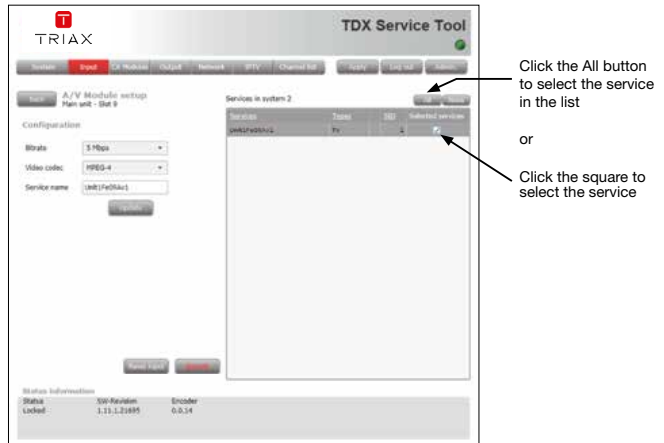

When you have selected the service, click the Submit button to enter this information into the headend system and return to the Input window.

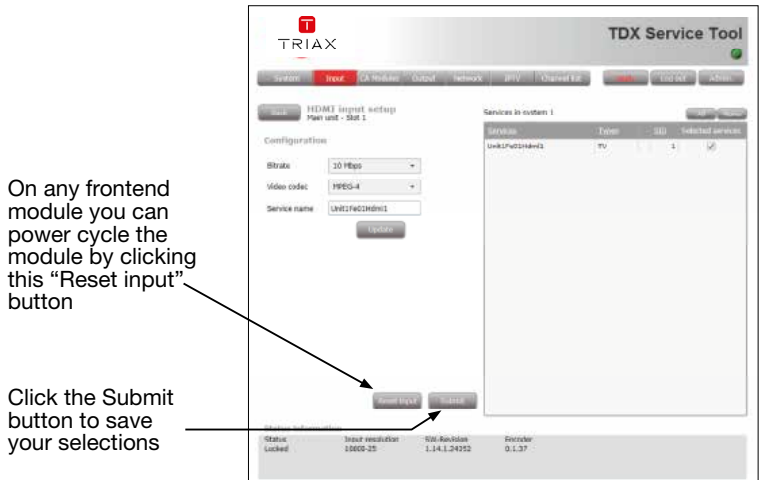

Now the selected services are available in the TDX service pool. Remember to click the Apply button in the upper right-hand corner to save new settings in the configuration.

Note When you display the Configuration window for an input module that has been configured, all fields are filled in and services have been selected.

If you want to change the existing bitrate and video codec just follow the same procedure as when you configure an input module for the very first time.

TDX Service Tool

Settings

In the setup window you can set your Bitrate and Video codec in the drop down menus

You can choose bitrate setting in steps of 1 Mbps

Select MPEG setting



Status information

Status information is placed at the bottom of the Configuration window. The information displayed in the configuration window of a HDMI- or AV module includes the status of the module and revision of software.

Information



Status

Informs you whether the input module is locked or not.

SW revision

Displays the software version of the input module.

TDX Service Tool

Errors

In case of errors you can read the cause in the Status information line at the bottom of the Configuration window.

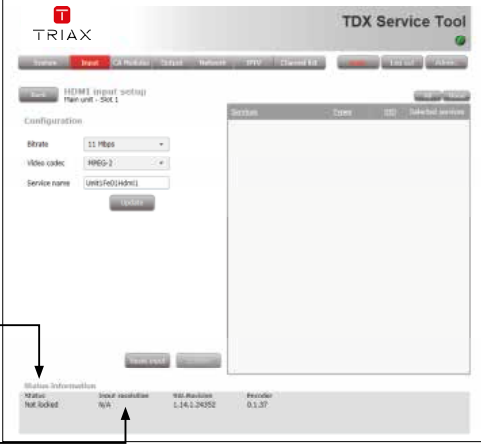

The screenshot shows the TDX Service Tool interface. The 'Configuration' section has 'Ebrate' set to 11 Mbps, 'Video codec' set to MPEG-2, and 'Service name' set to UMtsFO(HDMI). The 'Status Information' section at the bottom shows 'Status' as 'Not locked', 'Input resolution' as 'N/A', 'Max Resolution' as '1.141.240SS', and 'Framerate' as '0.137'. Two arrows point from the numbered list to the 'Input resolution' and 'Status' fields.

- 1 No source
- 2 Not a valid resolution, e.g. 1080p

Note The HDMI module complies with the HDCP standard. This means protected content is not allowed for broadcast and the result is a black picture!

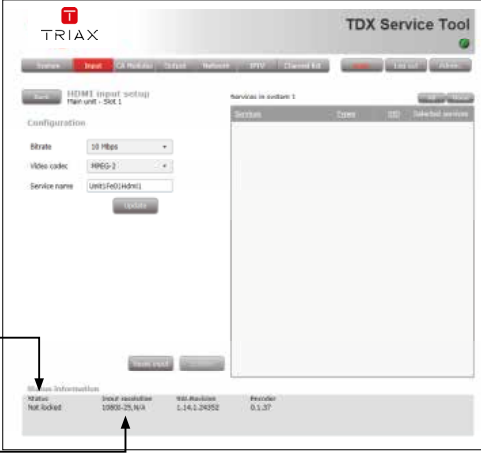

The screenshot shows the TDX Service Tool interface. The 'Configuration' section has 'Ebrate' set to 50 Mbps, 'Video codec' set to MPEG-2, and 'Service name' set to UMtsFO(HDMI). The 'Status Information' section at the bottom shows 'Status' as 'Not locked', 'Input resolution' as '1080i-25,6/4', 'Max Resolution' as '1.141.240SS', and 'Framerate' as '0.137'. Two arrows point from the numbered list to the 'Input resolution' and 'Status' fields.

- 1 No source
- 2 To high resolution for MPEG 2 encoding

TDX Service Tool

Status information

When you return to the Input window the configuration of the input module is displayed in the module list.

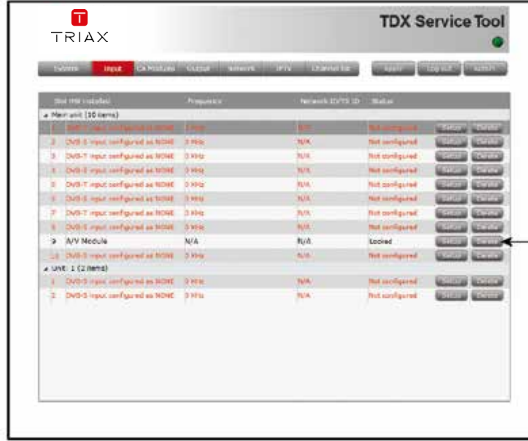

AV module that has been configured

Now you can continue to configure the other input modules one by one, following the procedure described on the previous pages.

Delete setup

If you want to remove an HDMI input module and the associated configuration you can use the Delete button of the module in question in the Input window.

Click the Delete button of the input module you want to remove. A message window is displayed asking you to confirm that you want to remove the input module.



TDX Service Tool

Until you have removed the input module physically from the headend unit the module list will display a line with the writing in red.

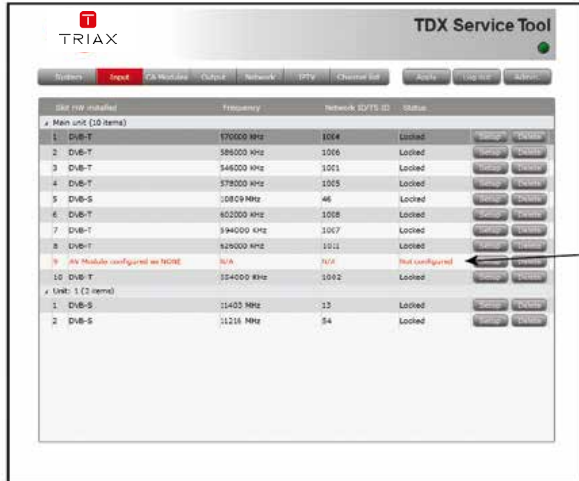

The configuration has been deleted

Save configuration

An **important button** when you change your configuration of the headend system is the Apply button placed in the upper right-hand corner of the TDX Service Tool window.

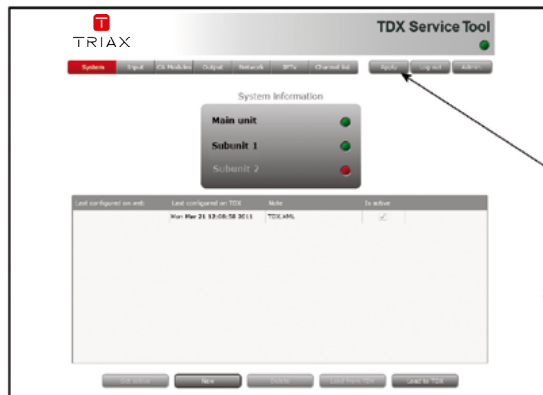

Click the Apply button to save the changes

Apply

Whenever you have made changes in your configuration, “Apply” on the Apply button turns red, to tell you that you have unsaved changes that need to be saved.

Click the Apply button to **save** the changes. When changes have been saved the “Apply” text loses the red colour.

WARNING - All unsaved changes will be lost in case of a power cut

TDX Service Tool

Update MPEG encoder module

In very rare instances you will have to update the MPEG encoder module on the PCB of the HDMI module.

If the MPEG encoder module needs to be updated you will receive an SD card containing the update files from Triax.

To update the MPEG encoder module follow the procedure below:

- Remove the HDMI module from its slot in the TDX unit while power is on.
- Slide the SD card into the SD slot at the back of the HDMI module.
- Insert the input module into the slot in the TDX unit while power is on.

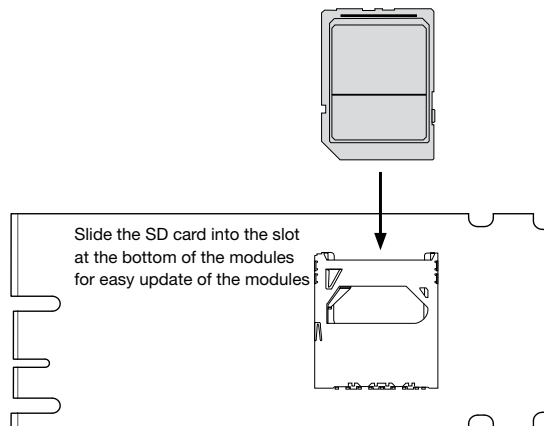

The colour of the LED on the input module indicates how the update process is progressing:

- Red - fast flashing** The MPEG encoder module is now being updated.
- Green - fast flashing** The update of the MPEG encoder module is completed.
- No colour** Power has not been switched on.

Proceed as follows (when update has completed)

1. Remove the input module from the slot in the TDX unit.
2. Remove the SD card from the slot at the back of the input module.
3. Reinsert the input module into its slot in the TDX unit.

If the update of the MPEG encoder module requires that the TDX system is updated as well, the colour of the LED on the input module and the System LED on the TDX unit will turn red and you will get an error message in the System information window.

TDX Service Tool

The illustration below displays the error message you will receive if the TDX system needs to be updated after the MPEG encoder module has been updated.

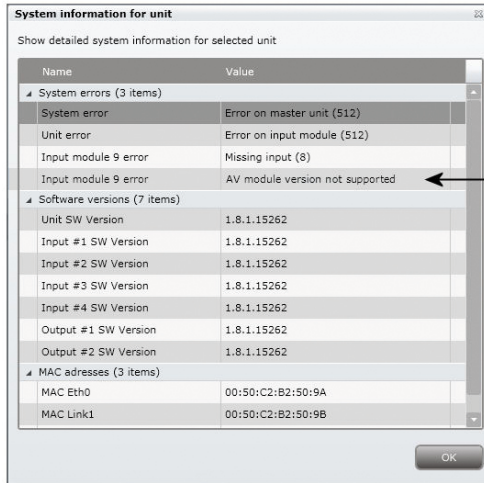

This message will be displayed if you need to update the TDX system following the update of the MPEG encoder module

Technical data

Type **TDX - HDMI frontend encoder module**

Description The HDMI encoder module converts digital audio and video signals from a set top box, a DVD player, a camera, laptop or other sources, into a MPEG4 or MPEG2 data stream. This data stream is then available in the TDX pool and can be sent out on all TDX output modules.

Features HDMI input (HDCP compliant)
HDMI to IP
State of the art real time MPEG4 or MPEG2 encoder
Hot swap service in TDX system
Selectable encoder output bandwidth (TDX GUI)

Technical data

Product		HDMI encoder module
Art. No.		492030
HDMI input		HDMI (HDCP compliant (see Note 1)
Connector		1 x HDMI female (Type A)
Video formats		480i; 480p; 576i; 576p; 720P; 1080i
Audio format type 1	ks/s	LPCM (32; 44.1; 48.0)
Audio format type 2		AC3 pass thru
Output		
Output format		MPEG transport stream (LVDS)
Connector		Edge connector for PCIe x1
Video Coding option 1 (GUI)		MPEG-2 (Embedded audio type 1)
Video Coding option 2 (GUI)		MPEG-4 (Embedded audio type 2)
Embedded audio type 1 (Auto)	ks/s	MP2 (48.0 kHz)
Embedded audio type 2 (Auto)	ks/s	AAC (48.0 kHz)
Bandwidth options (GUI)	Mbps	2..12 in steps of 1Mb/s (see Note 2)
Environment		
Voltage/current	V/mA	12 / <220
Temperature, operating	°C	-10...+50
Temperature, storage	°C	-20...+70
Mechanical data		
Dimensions, product	mm	126 x 53 x 29
Dimensions, in carton	mm	183 x 266 x 55
Weight, net/gross	g	50/250
Audio/Video input connector		HDMI
System connector		Edge connector 2X18P
Remarks		Use high quality 3D HDMI cable only - art. no. 153420 HDMI cable - 2m

Note 1

Will NOT allow Protected content.

Note 2

Bandwidth covers video, audio, and overhead for streaming fluctuations. Equivalent video bandwidth will be approximately 25% below selected bandwidth.

Type

TDX - AV frontend encoder module

Description

1 Channel SD A/V MPEG-2 encoder, 2 channel audio, Teletext

Features

CVBS input only.
Stereo audio input
Colour standards PAL, SECAM, (NTSC)
Teletext.
System interface compatible with "TDX FrontEnd".
(Comprising "Hot swap" among other features).
Selectable encoder output bandwidth (TDX-GUI)
Remote update via TDX system interface

Technical data

Product		AV encoder module
Art. No.		492080
Video input		1 x AV-signal
Video level	Vpp	1.0
Video impedance	Ohm	75
Return loss	dB	> 26
Video S/N ratio	dB	> 53
Physical input		CVBS
Scan resolution	p	525, 625
Colour standards		PAL, Secam, NTSC
VBI data slicer		Teletext
Input aspect ratio		4:3, 16:9
Audio input		
Audio input level	Vpp	< 2.4
Audio impedance	kOhm	10 ±1
S/N ratio	dB	> 55
Input frequency range (- 3 dB)	Hz	50-20.000
Max. harmonic distortion	%	< 1.0
Output		
Output format		Serial MPEG transport stream (LVDS)
Video codec		MPEG-2, MPEG-4
Video codec settings (CBR)	Mb	1, 2.5, 5.0, 10.0 (MPEG-2, MPEG-4)
Embedded audio - MPEG2/MPEG4	kHz	MPEG2L1, 44.1/ AAC, 48.0
Audio bitrate, fixed	kB	192
Power/Environment		
Voltage/current	V/mA	12 / <220
Temperature, operating	°C	-10...+50
Temperature, storage	°C	-20...+70
Mechanical data		
Dimensions, product	mm	126 x 53 x 29
Dimensions, in carton	mm	183 x 266 x 55
Weight, net/gross	g	50/250
Audio/Video input connector		D-Sub type 15p HD (DE15)
System connector		Edge connector 2X18P
Remarks		15pol Sub-D/3xRCA cable - art. no. 300745



TRIAX

connecting the future

Dear Customer,

Should you require technical assistance in the event that your expert dealer is unable to help you, please contact us at:

Triax A/S
Bjørnkærvej 3
8783 Hornslyd
Denmark

Tel.: +45 76 82 22 00
mail: triax@triax.dk
web: www.triax.dk

DECLARATION OF CONFORMITY

TRIAX confirms that the product conforms to relevant EEC harmonised standards and consequently can carry the CE-mark.

Relevant harmonised standards:

DE/EN 60728-2 2010, DS/EN 60728-11 2010 and DS/EN 50083-2 2006

This document is only valid with the signature of the person responsible for CE-marking by Triax

Date: October 2012

Signature:

triax.com/support



Copyright © 2016 TRIAX. All rights reserved. The TRIAX Logo and TRIAX, TRIAX Multimedia are registered trademarks or trademarks of the TRIAX Company or its affiliates. All specifications in this guide are subject to change without further notice.

TRIAX A/S | Bjørnkærvej 3 | DK-8783 Hornslyd | Denmark